

# USER MANUAL

Model: **MOTOR-06**

---

**Tips:** Please read this manual carefully before use and keep it properly.  
Do not ride until you know the performance of this product.

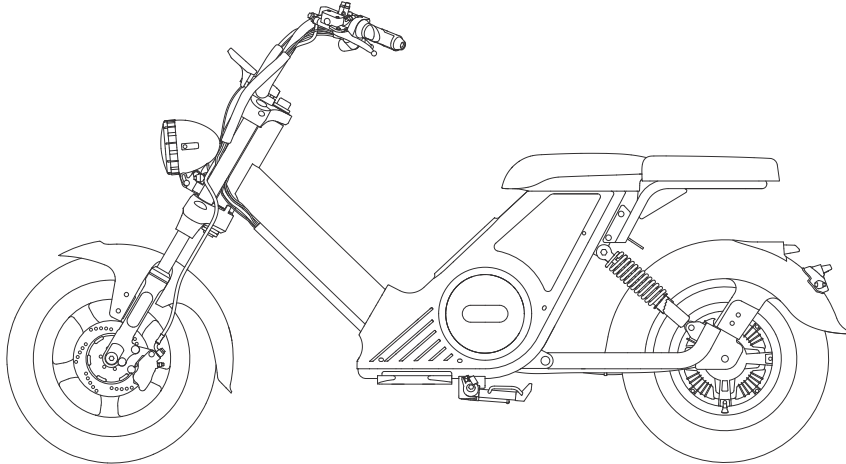

**PXiD**

# Content

Welcome .....	01
1. Safety instructions .....	02
2. Products and accessories .....	05
3. Function diagram .....	06
4. How to assembly .....	10
5. Check before riding .....	12
6. How to ride .....	12
7. How to charge .....	14
8. Product specifications .....	16
9. Daily maintenance .....	17
10. Warranty service .....	21
11. Trademarks and legal statements .....	22

# Welcome

---

Thank you for choosing PXID Motor-06 electric motorcycle (hereinafter referred to as M6).

This electric motorcycle is a safe and fashionable transportation tool. Enjoy free riding and speed control from now on!

In order to ensure the safety, please read this manual carefully before riding to meet the relevant conditions.

**Join PXID Cycling Club and we look forward to meeting you on social media!**



Pxid Bike



Bike Pxid



pxid\_bike



@PxidBike

Tag us! @PXID #PXID

# Contact us

---

**Company:** Huaian PX Intelligent Manufacturing Co.,Ltd.

**Add:** No.18, Shenzhen East Road, Qingjiangpu District, HuaiAn, JiangSu

**Email:** inquiry@pxid.com

**Website:** www.pxid.com

# 1.Safety instructions

1. electric motorcycles are a recreational product. In order to ensure the safety of cyclists, please read this manual carefully before using this product, practice and master the riding skills through the correct guidance. If the rider is inexperienced or does not use in accordance with this manual, the company (the company refers to Huaian PX Intelligent Manufacturing Co., Ltd. and its affiliates) will not bear any responsibility for any damage.
2. Please follow local laws and traffic regulations. Do not ride electric motorcycles in areas where they are prohibited by law. Do not ride electric motorcycles on public transport roads. Do not ride on the road infested with motor bikes under any circumstances, otherwise serious injury or death may result.
3. There is a risk of injury or death from loss of the electric motorcycle control, collisions and falls when using electric motorcycle. To reduce risk, riders must read and follow all "cautions" and "warnings" in the instructions. Following the warnings and tips in this manual reduces risk, but does not eliminate all risk. Please ride with caution and knowledge of driving.
4. This product must be assembled and adjusted by the rider's guardian or other adult. This product should not be accessible to people under 16 years of age.
5. The package contains wrenches, plastic bags and other items. Please keep them away from minors.
6. Do not give the electric motorcycle to someone who cannot operate it. Please ensure that others are aware of the correct usage of this product before giving it to them for use. You are responsible for the safety of new riders. Please assist him/her in learning to use the product until he/she has learned the basic operation. Please ensure that each new rider wears a helmet and other protective gear and uses them if a guardian is required. Please deliver the product with this instruction when you hand it over to others.

## Riding environment and pavement

1. Avoid riding on steep slopes, bumpy roads, slippery roads, pits, sewage openings, stairs, snow, water edges, near furnaces,



flower beds, expansion joints, construction roads, debris and other obstacles. When riding, you should observe and avoid traffic at any time, and try to keep a slow cycling speed. Too fast cycling is prone to accidents such as bike losing control and falling injury.

2. For whatever reason, do not ride in snowy, rainy, slippery, muddy, or icy conditions. Doing so could cause the bike to lose its balance or grip, leading to a fall. Riding in rainy weather can cause water to enter the bike, leading to the risk of functional damage, fire or even explosion due to the wet battery. Damage and loss due to water intake are not covered by the warranty.

3. Please do not ride in bad weather or poor visibility (e.g. at night).

### **Riding precautions**

1. Only one person is allowed to ride the Electric motorcycle. Overloading is strictly prohibited!

2. Please wear helmets and knee and elbow pads when riding. Please use a good quality electric motorcycle helmet.

3. Grip the handlebars with both hands when riding. Do not hang ornaments, heavy objects, etc. from the handlebars.

4. Do not speed up or slow down suddenly while riding. Please do not go faster than the electric motorcycle limit.

5. When riding, avoid putting your hands and feet into the rolling wheel.

6. When riding, please pay attention to the road conditions and avoid obstacles and roads that are not easy to ride (including but not limited to slippery ground, loose sand, gravel ground and ice).

### **⚠ Warning**

**If the electric motorcycle gives out abnormal sound or alarm sound, please stop using it immediately, and call the after-sales service number 400-853-2909 to obtain professional guidance or maintenance service.**

### **Rider requirements**

People who are not suitable to ride this product include:

I. Persons under the influence of alcohol or drugs.

II. Persons who are unable to perform strenuous physical activity due to medical conditions, especially those with heart,

neck, back, etc.

III. People who can't keep their balance.

IV. Persons whose age, height and weight are not within the prescribed limits.

V. Persons with limited intelligence who are unable to understand the proper use of electric motorcycles and the associated risks.

### Operation notice

1. Only parts and accessories designated or approved by the company can be used. Do not modify the Electric motorcycle, otherwise it may affect the operation, leading to serious injury/damage and warranty void. Electric motorcycle contains electrical components, do not remove.

2. Do not drive the electric motorcycle when the ambient temperature exceeds the operating temperature of the product (please refer to the "Product specifications"), because low/high temperature will lead to the limitation of the maximum power and the degradation of the product performance. Doing so may cause a slip or fall, or even result in personal injury or property damage.

3. Please do not let minors touch fenders, wheels and other structures with gaps. Do not touch the brake or hub motor after riding to avoid burns caused by elevated component temperature.

4. Please park the electric motorcycle on the flat and firm road as much as possible. It is recommended to park near the wall. Do not park in busy areas. If parked on the slope, the electric motorcycle foot support must be oriented downhill to prevent overturning. Please do not let the electric motorcycle head down, to prevent the kickstand closed and bike fall over under the action of gravity. After putting down the kickstand, please check whether the body of the bike is stable, to prevent the bike from falling over(due to sliding, wind or shaking etc.).

5. Regular maintenance of product is recommended for a better driving experience (see "Daily care and maintenance").

6. Users must read the charging steps and precautions in this manual before charging (please refer to "How to Charge").

## 2.Products and accessories

Carton:

Accessories

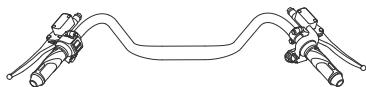

Handlebar×1



Mobile phone holder



Rear view mirror×2



Allen×4

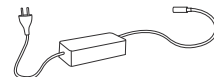

Charger×1

Accessories

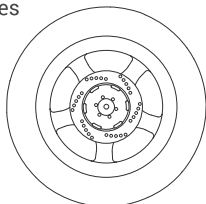

Front wheel×1

User information

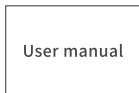

User manual

User manual×1



Warranty

Warranty×1



Certification

Certification×1

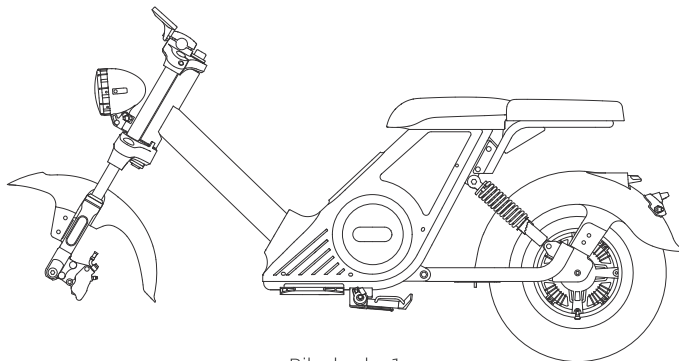

Bike body×1

Please carefully check whether the items in the packaging box are complete and in fact of any missing or broken items.

### 3.Function diagram

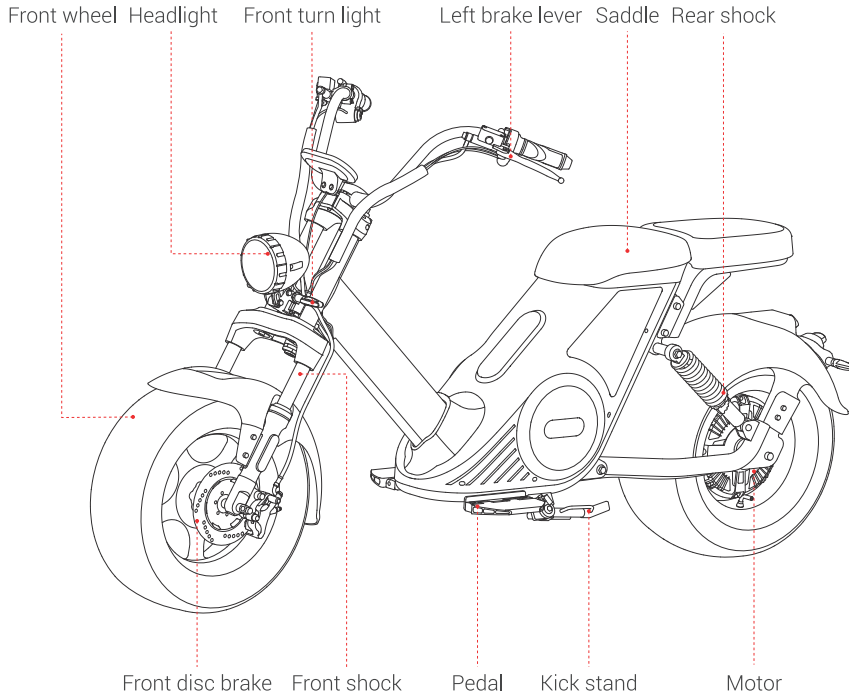

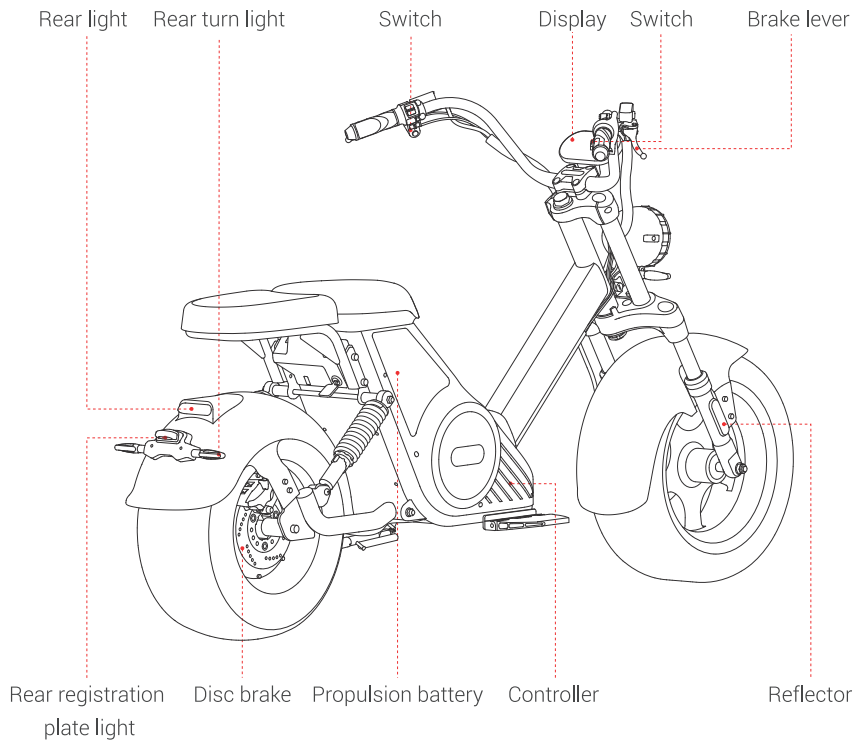



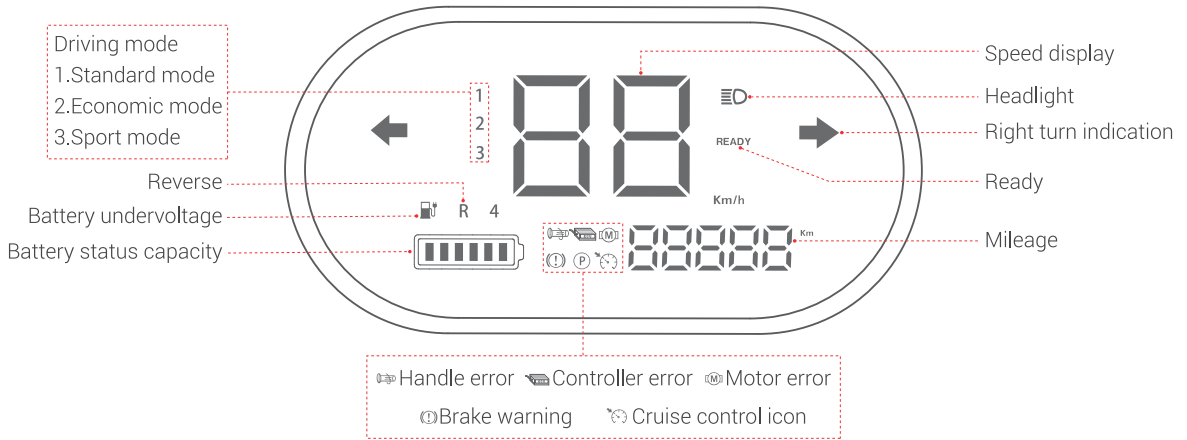



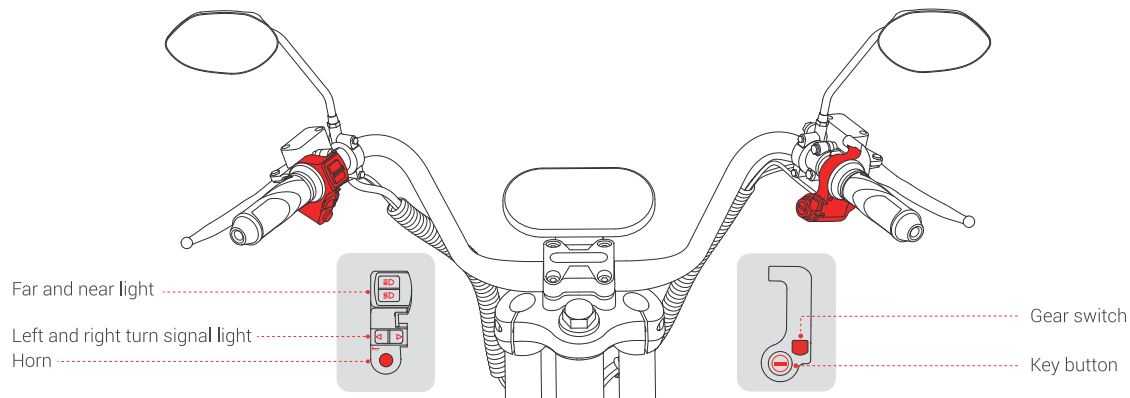



# Display



## Head combination switch



	Gear switch	After pressing the  button in turn, quickly switch the driving mode (1/2/3 gear), thereby changing the driving speed threshold.
	Far and near lights	Press the  button up to turn on the near light. Press the  button down to turn on the far light.
	Turn signal	Press left  to turn on the left turn signal light; press right to  turn on the right turn signal light.
	Horn	Short press the horn button, the horn will sound.

## 4.Body assembly

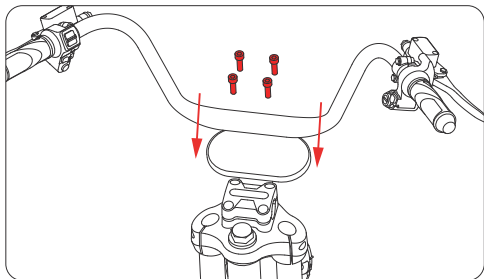

1. To fix the front of the car, first unscrew the screws on the card slot, and place the handlebar kit corresponding to the card slot. (Note: Do not remove the cable tie on the brake lever first)

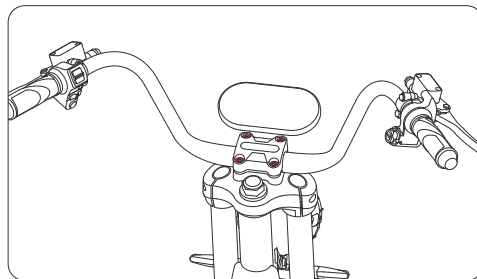

2. Secure the handlebar kit, use a screwdriver to tighten the screws diagonally, and the installation is complete. (Note: After installation, remove the cable tie on the brake lever)

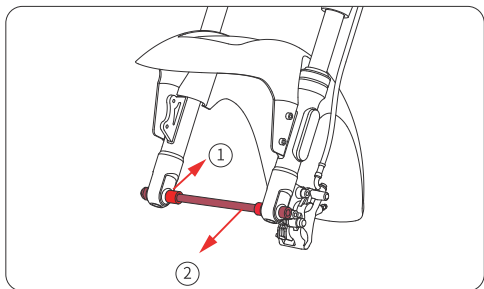

3. To install the connecting rod, first place the bushing ① corresponding to the inner hole of the front shock absorber, then install the connecting rod ② through the bushing and the front shock absorption hole position, and fix the right front shock absorption hole with screws first.

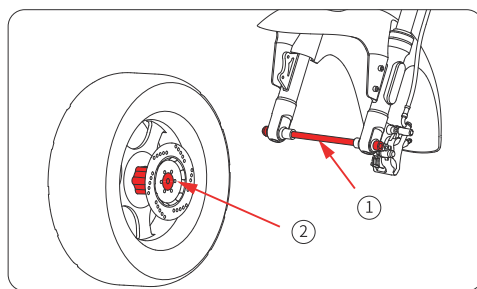

4. Install the front wheel, the connecting rod ① passes through the front wheel shaft ② and corresponds to the left front shock absorber hole, and fix it with screws.



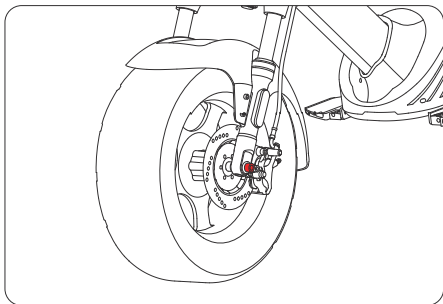

5. Put the wheel straight, check the gap between the brake disc and the caliper, otherwise it will cause the disc to rub. After installation, tighten the nuts on both sides.

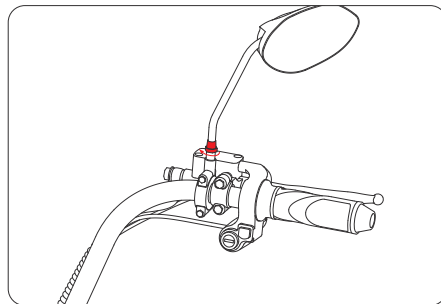

6. As shown in the figure, screw the rear-view mirror clockwise to the proper position, and tighten the nut clockwise.

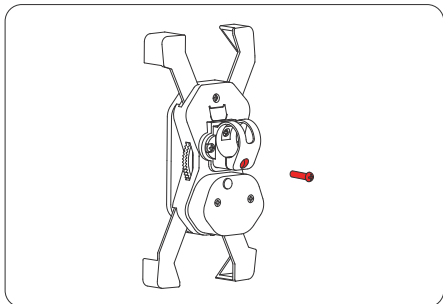

7. Take out the screws on the back of the phone holder as shown in the figure.

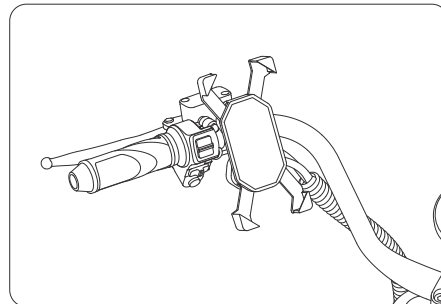

8. Place the phone holder at the proper position of the handle, and then screw the screw removed in step 7 back into the original screw hole.

## 5. Check before riding

To reduce the occurrence of accidental injuries, the following items should be checked before each ride:

1. Check bike status, tire and brake effect, etc. Ensure that no parts including the handlebars, risers, tires, brake lines, brake handles, fenders, and screws show any signs of loosening or damage.
2. When the power is low, the Electric motorcycle does not have enough power to maintain normal cycling. Please make sure that the power is sufficient to avoid danger.
3. Must wear a helmet and a full set of knee pads, wrist pads, elbow pads, wear sports shoes, and wear clothes suitable for sports. Long hair or enough to affect the line of sight bangs, broken hair should be tied up, so as not to block the line of sight affect normal riding.
4. For your first ride, please do not choose the areas where children, pedestrians, pets, vehicles or other obstacles and potential hazards may occur.

**Note:** If there are any abnormal signs, please stop using it immediately and contact the after-sales service for testing guidance.

## 6. How to ride

1. Preparation:

There is a risk of falling and injury, so wear a helmet and protective gear all the time.

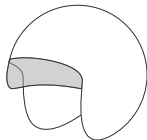

Helmet

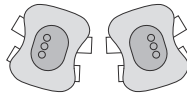

Protective

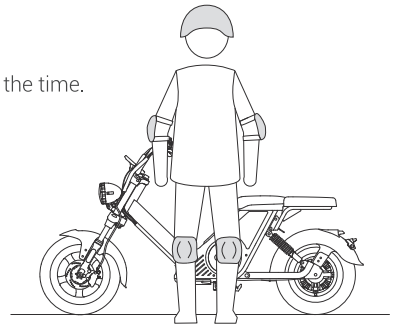

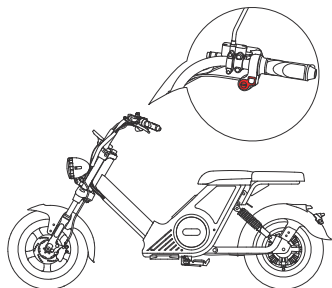

2. Power on: Turn the key to the right to power on, turn the headlight twice to turn on; and check the battery indicator. If the battery is too low, please charge it immediately.

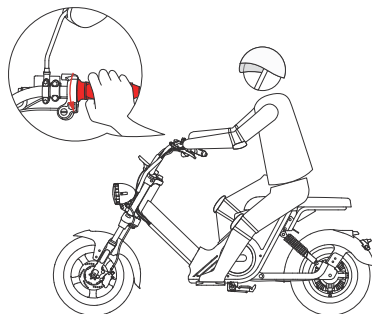

3. Start: Straighten the body before driving, adjust the sitting position, and after confirming that the gear is in low speed, slowly turn the throttle knob downward, and slide your feet on the ground; after the vehicle runs smoothly, retract your feet and place them on the pedals.

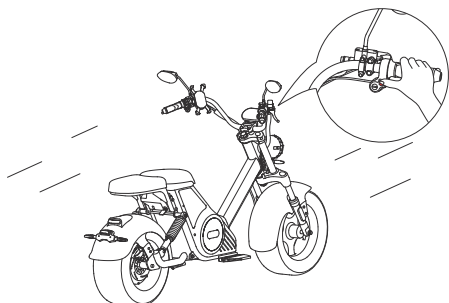

4. Acceleration mode switching: The shift button can perform 1 to 3 gear shifting.

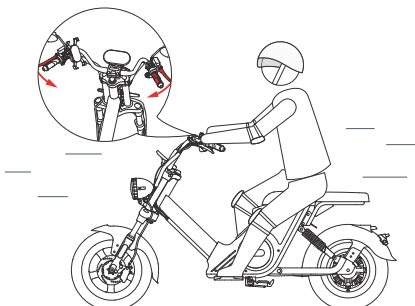

5. Deceleration/Brake: Release the throttle lever to slow down. Emergency braking requires a quick press on the brake lever.

**Warning:** Quick braking may fall due to insufficient.

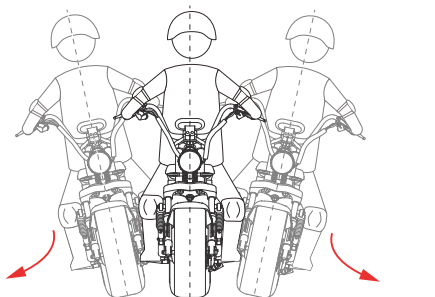

6. Turning: When turning, lean your center of gravity slightly and slowly turn your handle.

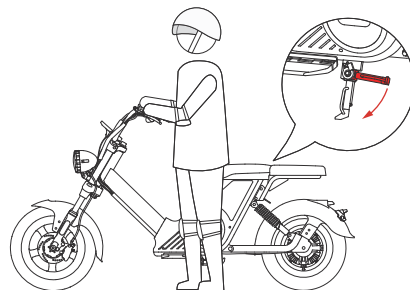

7. Get off: After the ride, please park the electric motorcycle on a flat road and press and hold the power on/off to turn off the power; put down the foot support to avoid rolling or tipping the electric motorcycle.

## 7.How to charge

Due to the self consumption of the battery during transportation and storage, it is normal the low or no power for the first time. Please follow the charging steps below. Do not allow child to operate the charging equipment.

### Charging: battery extraction charging/body charging

Find the battery under the seat cushion, unlock the seat with the key first, rotate the seat upwards and then extract the battery. The output end of the charger is connected to the body charging port, and then the power is turned on.

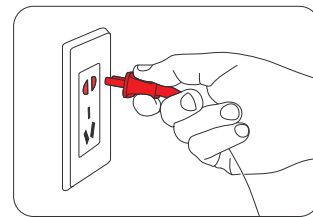
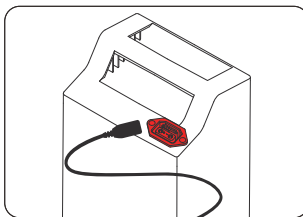
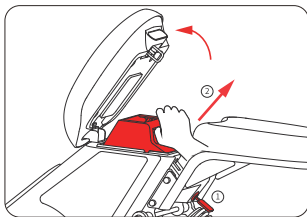

\*When the seat is not unlocked, please do not pull the seat up, the leather of the seat is soft and easily deformed and damaged under strong force.

The red light of the charger is always on to indicate that it is charging, and the green light is always on when charging is complete. Please power off in time when the battery is fully charged.

 **Warning**

1. Please charge when the bike power off.
2. Please use the original charger and only use the charger designated or approved by the supplier, otherwise the battery may be damaged or ignited.
3. Do not charge when the charging port, power socket or charging line is wet. If the vehicle is flooded, the battery is damaged or flooded, it is prohibited to charge or continue to use the battery.
4. In the process of charging, if the indicator light is abnormal or there is abnormal smell, stop charging immediately and contact the after-sales service or replace the charger.
5. The charger shall be kept away from inflammables and explosives when working. The charger is not a toy. Please place it in a safe place where child cannot touch.
6. Disconnect the power immediately after charging. Do not connect the charger to the power supply for a long time when it is not charged.
7. It is necessary to regularly check whether the charger wires, plugs, housings and other parts are damaged. In case of damage, it shall be stopped use until it is repaired or replaced.

## 8.Product specifications

Model	Motor-06
Colour	Green/Blue/Orange/OEM color
Maximum battery capacity	60V 30Ah
Maximum range	60km/h
Motor	60V3000W
Tire	12 inch aluminum wheel
Standard working voltage	60V
Battery Type	Lithium battery
Brake	Front and rear hydraulic disc brakes
Rated maximum load	200Kg
Lights	Front and rear lights (functions include low beam, high beam, turn signal)
Net weight	76kg
Gross weight	87kg
Expanded size	1990*840*1080mm
Storage temperature	0 C ~35 C
Charging temperature	10~35 C

You can choose the appropriate version according to your own needs. Motor-06 will launch various optional upgrade accessories and color style kits in the future. For details, please consult your dealer.

## 9. Daily maintenance

Users should follow the following tips to maintain and maintain electric motorcycles:

### Clean

Wipe the main frame clean with a soft damp cloth. For hard-to-clean stains, use a professional cleaner to scrub repeatedly, then clean with a soft damp cloth.

**Note:** Do not use alcohol, gasoline, kerosene or other corrosive and volatile solvents to clean. These substances may damage the exterior and interior structure of the vehicle body.

### Warning

- Do not use pressure water guns or hose sprays for flushing.
- During the cleaning process, keep the electric motorcycle turned off, unplug the charging cable and fasten the rubber cover of the charging port, otherwise it may cause electric shock or serious failure due to internal water.

### Storage

When not in use, try to store it in a dry and cool place indoors, and try to avoid storing it outdoors for a long time. Sun exposure/hot/cold outdoor conditions will accelerate the aging of the appearance and tires and reduce the service life of the body and its battery pack. Before storing, please fully charge the electric motorcycle, if it is not used for a long time, please charge it regularly to prevent the battery from discharging. Do not store it in a dusty environment to avoid damage to electrical components. Can not be stored together with chemicals, acids, alkalis and other substances.

** Warning Do not go near the fire source!**

### Move

Before moving, make sure that the electric motorcycle is turned off. During the handling process, please handle with care, do not throw, heavy pressure, rain, moisture and violent collision are strictly prohibited.

## Battery Maintenance and Recycling

A well-maintained battery will keep running well even after many miles of driving. Generally speaking, a fully charged battery will use up its stored power in 120-180 days after it is turned off. If it is not used for a long time, it should be charged every 30-60 days. Charge the battery after each drive. A completely depleted battery may cause permanent damage. There is a smart chip inside the battery to record the charge and discharge of the battery. Damage due to over charging or undercharging is not covered under warranty.

- Do not remove or disassemble the battery.
- Do not use other types or brands of battery packs, otherwise there may be safety risks.
- It is forbidden to charge in areas that are prohibited by the laws of the country/region and relevant management units.
- Do not touch the battery contacts and do not open or puncture the case. Avoid metal objects touching the battery contacts to cause a short circuit, otherwise it may cause battery damage or personal injury.
- Do not throw the battery pack into a fire, otherwise it may cause the battery to fail, overheat, or even risk a fire.
- When storing or charging the battery, do not exceed the specified temperature limits (see "Product Specifications").
- Improper disposal of used batteries can seriously pollute the environment. Waste batteries cannot be dismantled without authorization, and should be recycled by relevant professional departments. Please comply with local regulations and do not discard the battery pack arbitrarily to protect the natural environment.

## Charger

- Chargers should be used exclusively for vehicles, and it is strictly forbidden to charge non-rechargeable batteries;
- Confirm whether the connected power is 110V-220V AC power;
- If you find damaged lines or loose connectors, do not use them, please contact the after-sales service or designated authorized service;
- When charging, the vehicle should be in a safe place, beware of rain and sun exposure;
- When charging, insert the vehicle's charging port first, then the charger's power plug;



- During the charging process, if the indicator light is abnormal, there is a strange smell or the charger case is overheated, the charging should be cut off immediately;
- After the battery is fully charged, unplug the charger first, and then unplug the charger;
- After the charger has cooled down, tidy up the power cord and charging cable and place them in a safe place;

### Other

- When the brake cable is loose or the brake is not sensitive, the brake cable screw can be adjusted.
- The external cord of the charger cannot be replaced. If the cord is damaged, please replace the charger in time.
- Tire repairs should be performed by professional service personnel.

## Self Maintenance Guide

1. The first maintenance shall be carried out 1000 km after delivery of the new bike or 3 months after delivery (whichever comes first).
2. After the first warranty, it is recommended to maintain once every 2000 km or 6 months (whichever comes first).

### Specific maintenance rules and items and requirements

Maintenance project	Maintenance time (month)	3	9	15	21	27	33
	Maintenance mileage (km)	1000	3000	5000	7000	9000	9000
Adjust or replace front and rear brakes		A	A/R	A	A/R	A	A/R
Check handlebar steering		C	C	C	C	C	C
Check the tire pressure		C	C	C	C	C	C
Check the disc brake system		C	C	C	C	C	C
Tighten main component		T	T	T	T	T	T
Lubrication of main parts		L	L	L	L	L	L
Front and rear shock absorption adjustment		A	A	A	A	A	A
Check Light system		C	C	C	C	C	C
A: Adjust C: Check L: Lubricate T: Tighten R: Replace							

# 10. Warranty service

## 1. Warranty parts

Type	Warranty parts	Time
Body frame	Frame	2 year
Spare parts	Battery, motor, controller, charger	1 year
Appearance delicate parts	Handles, front and rear fenders, crank chains, reflective stickers, seat pads, brake pads	3 months

## 2. Non-warranty provision

1. Unauthorized maintenance, misuse, collision, negligence, abuse, liquid entry, accident, change, incorrect use of accessories other than this product, or tear, change or anti-counterfeit labels;
2. The warranty period has expired;
3. Damage caused by force majeure;
4. It does not meet the conditions of performance failure listed in the following "Electric vehicle Performance Error Sheet";
5. Failure to use, maintain and adjust in accordance with the requirements in the "Instruction Manual" will lead to performance failure of e-vehicles
6. Damage caused by human causes (including but not limited to punctured tires, collisions, marks and damage caused by normal use of appearance delicate parts, etc.);
7. Failure and damage caused by abnormal use of the product (including but not limited to overload, stepping down, falling, extreme sports, etc.);
8. If the Product is used for commercial purposes, there is no warranty.

## 3. Electric vehicle Performance Error Sheet

Product	Performance Error
Electric motorcycle	1. The motor can't work during normal use; 3. The charger error during normal use; 2. The controller is faulty during normal use; 4. The battery is error during normal use;

# 11. Trademarks and legal statements

## 1. Trademark and Copyright law Statement

PXID is a registered trademark of Huaian PX Intelligent Manufacturing Co., Ltd. Android is a trademark of Google; AppStore is Apple's service trademark; Other trademarks mentioned in the text belong to their owners. This manual has been printed as much as possible to include the introduction of various functions and instructions. However, due to the continuous improvement of product functions, design changes, etc., there may still be discrepancies with the products you buy. Please scan the APP QR code in the instructions, download the product APP for Android or iOS system and read the electronic version of the latest instructions. Due to the product update, the product mentioned in this instructions may be different from the product you actually purchased in terms of color and appearance. Please refer to the actual product.

©Huaian PX Intelligent Manufacturing Co., Ltd. reserves all rights.

## 2. Product legal Statement

The more familiar you are with this product, the safer you will be when riding. Please pay more attention on the followings:

- (1) Read the product instructions carefully. If you cannot ride the product according to the instructions, please do not attempt to ride the product.
- (2) Please do not allow people who have not read this manual carefully to use the product. When you lend your product to others, you must deliver the product together with the product description, and inform them of the use method and safety tips.
- (3) Purchase insurance in time after purchasing this product, so as to minimize the risk of use.
- (4) You are obliged to be aware of all relevant laws, regulations and policies regarding electric motorcycles in your area and strictly comply with the applicable laws, regulations and policies. Avoid ride in areas that are not allowed by local laws, regulations or policies.
- (5) When you receive this product, please immediately check whether the product and accessories are intact and complete.

Due to the special needs of the bike in the logistics transportation, we will use the packing box to ensure its transportation safety. In order to make you better enjoy the services we provide for you, it is recommended that you keep the packing box for at least 15 days from the date of product receipt.

(6) All PXID products should be assembled correctly according to the instructions, improper installation may bring out of control, collision or fall, please turn off the power before installation or maintenance, in the installation of components, please strength appropriate, installation too loose or too tight may lead to product damage or present fault.

(7) This product may contain detachable parts, which should be protected from harm caused by children swallowing. (8) Before each use of this product, please do according to your purchase model corresponding to instruction manual check tyre performance, the running state of the battery and bike body installation status. To ensure that contains all parts of the brake, screw, nut, there's no sign of loose or damaged, avoid the body or part poor state influence your normal driving, and even accidents.

(9) It is recommended to wear protective glasses when riding, which can prevent dirt, dust and insects in the air. Use lenses of different lightness: dark when fiber is strong, transparent when light is low.

(10) This product can only be loaded by one person. When riding, please keep alert and ride at an appropriate speed. No special effects are allowed during riding or riding.

(11) Do not park the product in the safety exit, evacuation passage and other prohibited parking areas. Do not throw or drop the product. Do not place the product on open flame or under high temperature.

(12) Use the original battery pack and charge the battery with the original charger. Otherwise, the charger or battery may be damaged or safety risks may occur.

(13) When charging, connect the power cable to the correct socket (110V-240V to 50Hz/60Hz), keep it away from children and pets, and keep it away from flammable objects. If the battery is damaged or flooded, do not use the battery after charging it. Do not charge this product when the socket is wet.

(14) It is strictly prohibited to immerse the battery or vehicle body in water or to be exposed to heavy rain or ride in the rain, so as to avoid water flooding in the battery compartment and circuit chip.

(15) Due to the work of the intelligent system and alarm system of the vehicle, the battery power will be consumed from time to time. After the battery is placed in the vehicle for a period of time, the meter shows that the power decline is normal. If the vehicle is not used for a long time (such as winter, summer or other special circumstances), please store the battery separately and maintain it regularly, otherwise it may cause the battery to run out completely and produce irreversible damage.

(16) Do not store the battery in an environment higher than 50°C or lower than -20°C, otherwise it will cause irreversible capacity decay of the battery.

(17) Please do not store the battery or vehicle in a place with a risk of falling, which may cause uncontrollable damage inside the battery and may lead to leakage, heat, smoke, fire or explosion of the battery.

(18) There are harmful substances in the battery. Please do not try to destroy the battery. The battery is not a repairable part. If the battery

has peculiar smell, heat, deformation or other abnormal conditions, please stop using it immediately, keep away from the battery and contact the after-sales department.

(19) Warning: Due to the user's failure to use and maintain the battery normally, the battery performance deteriorates or cannot be used normally, which is not within the scope of the three guarantees.

(20) Improper disposal of used batteries may seriously pollute the environment. Please do not discard the battery pack at will to jointly protect the natural environment. Observe local laws and regulations when disusing battery packs.

(21) Please avoid the use of non-original parts, and do not disassemble, crack or modify the product and parts without authorization. The damage and loss caused by this will be borne by you.

(22) If the product does not belong to the scope of warranty services, you need to pay for maintenance and related services.

(23) If this product and its parts need to be repaired or replaced during use, please keep the relevant after-sales service information after repair or replacement.

(24) Please strictly abide by the traffic laws and regulations in your area. Due to the differences in laws, regulations and policies of registration management and government control in different countries or regions, please confirm the local registration management and control policies and programs before purchase and use, and consult the relevant local management departments for relevant questions. The Company shall not bear any responsibility for any loss caused by the failure of registration or other policies and regulations.

### **3. Others**

(1) Product data and parameters vary with different models and are subject to change without prior notice.

(2) To the extent permitted by law, our Company reserves the right to interpret and explain this Statement.

(3) This Statement shall be governed by the laws of the People's Republic of China (except the laws of Hong Kong and Macao Special Administrative Regions and Taiwan Region of China). The Company shall not be liable for all claims, liabilities and losses arising or likely arising out of the Consumer's breach of the terms of the above statement. Drivers should be responsible for unforeseen or unavoidable risks encountered in the course of driving.

(4) If one day you want to resell or re-gift the product you purchased, please do not forget to forward this legal declaration with you as it is part of the product. If you have any questions, I'm glad to be at your service.

Thank you again for your choice and trust in this product.

